

Digital Indicating Controller LT45A/47A SERIES



LT45A/47A series is digital indicating controller with indicating accuracy of $\pm 0.1\%$ and the control cycle of approximately 0.1 second.

3 types of auto tuning functions and overshoot suppression functions achieve superior control stability.

Combination of internal computing function and enriched input and output option support various usage scenarios.

Special loader software provides ease of setting operations and data acquisition.

FEATURES

Compact design

Short depth of instrument (case 65mm) saves the space of instrument and control board.

Universal input

Input type is user-changeable from among thermocouple, resistance thermometer, DC voltage and DC current.

Outstanding controllability

Control system can be selected from two-position control and PID control.

It has overshoot suppression function and high-functional PID.

3 types of auto tuning

Can be selected from normal, rapid-response, stable tuning on the control target.

Various input / output signal (optional) are available.

Current transformer input 2 points, event output 3 points (Max), remote signal input 4 points and communication interface (RS485).

Conformance to international safety standards

CE marking, RoHS

Loader software is available

Various parameter settings and data acquisition can be done easily using loader software (sold separately).

PARTS NAMES OF FUNCTIONS

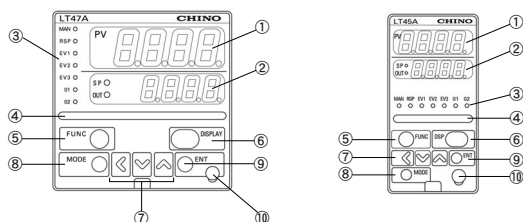

- ① Upper display: Displays PV values (temperature, etc.).
- ② Lower display: Displays SP values (preset temperature, etc.) or setting items.
- ③ Status display lamp: MAN: Lights when MANUAL (manual mode).
RSP: Lights when remote SP input. (Local SP input when light OFF)
EV1 to EV3: Lights when event outputs are ON
O1 to O2: Lights when the control output is ON
- ④ Multiple functions indicating lamp: Lights when the control output is ON
User-settable max. 3 sets combination of condition and status as preferred functions (alarm, READY, etc.).
- ⑤ [FUNC] key: Press 1 second or longer, then enters frequently used functions and operations set in advance. The function is disabled at factory default.
- ⑥ [DISPLAY]/[DSP] key: Switch display in operation mode. Or back to operation mode from parameter setting mode.
- ⑦ [MODE] key: Switches the display
- ⑧ <, V, ^ Key: Used for incrementing numeric values and performing arithmetic shift operation.
- ⑨ [ENT] key: Start to change setting and set value.
- ⑩ Loader connector: Connects to a personal computer by using USB loader cable.



MODELS

LT45A□□□□□□□□□□/LT47A□□□□□□□□□□

	Measur- ing input	Control output	I/O option	Terminal type	Power	Extra	Specifications	
LT45A							48mmX96mm front size	
LT47A							96mmX96mm front size	
0							Universal input	
							Control output 1	Control output 2
							ON-OFF pulse output	—
*3							ON-OFF servo output	—
							SSR drive pulse output	—
							SSR drive pulse output	Current output
							SSR drive pulse output	SSR drive pulse output
							SSR drive pulse output	Voltage output
							Current output	—
							Current output	Current output
							Current output	Voltage output
							Voltage output	—
							Voltage output	Voltage output
							Event output 3 points	
							Event output 3 points, Transmission signal output (current output)	
							Event output 3 points, Transmission signal output (voltage output)	
*3,5							Event output: 2 points (independent contact)	
*3							Event output: 2 points (independent contact), Transmission signal output (current output)	
*3							Event output: 2 points (independent contact) Transmission signal output (voltage output)	
0							—	
*1,2							Current transformer input: 2 points, External signal input: 4 points	
*1,2							Current transformer input: 2 points, External signal input: 4 points, Communication interface RS485	
*1,2							Current transformer input: 2 points, External signal input: 2 points, Remote signal input	
							Current transformer input: 2 points, External signal input: 2 points, Remote signal input, Communication interface RS485	
0							Terminal block type	
						A	100 to 240V AC, Terminal block type	
						D	24V AC/DC, Terminal block type	
						00	No additional treatment	
						Y0	Complying with the traceability certification	
						T0	Tropical treatment	
						K0	Sulfur resistance treatment	

*1: Current transformer is sold separately.
*2: Current transformer input not available when ON-OFF servo output is selected as control output. Then it becomes motorized feedback input.
*3: 24V AC/DC power supply can not be selected.
*4: Non-conforming to CE, UL/cUL.
*5: Event output are 2 types, specify models of 3 point (common) or 2 points (independent).

Compact Bodies

Easy-to-read display

On the display, measuring value (PV) is indicated in green and setting value (SP) is indicated in orange LEDs.

Frequently used operation can be assigned to the FUNC key

By assigning frequently used operation such as Auto/Manual and RUN/READY to the FUNC key, only one press of a button enables switching the functions.



There are size 48x96mm and 96x96mm available. Depth is only 65mm, so it is space saving for any installation

Advanced controllability

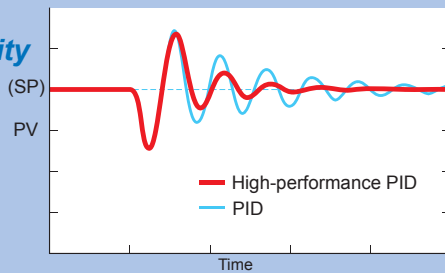

In addition to the conventional PID, "High-performance PID" is available which has unique algorithm aim to converge hunting quickly to decrease settling time.

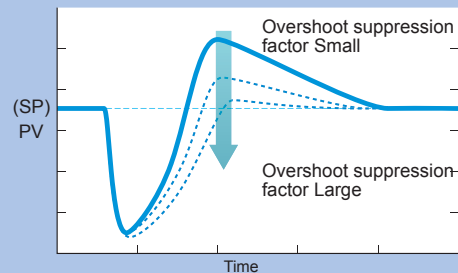

By "Overshoot suppression function" which controls overshoot at SP changing and/or disturbance response, the control has been able to develop stronger resistance for disturbance and superior stability.

Step control

Preset maximum 8 setting values and each step can reserve hold time and ramp setting. This function delivers maximum 8 steps program control

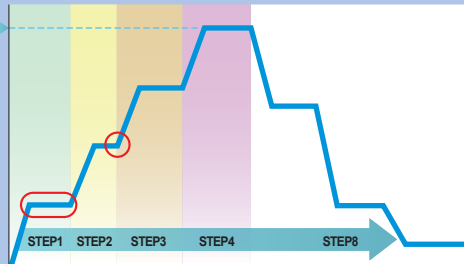

Three types of Auto tuning

Along with the standard algorithm, auto tuning for a target which has relatively good responsiveness and for a target which has good heat-retention are provided to perform appropriate control easily.

Zone PID control

When PID parameter change is necessary depending on the temperature range such a case as furnace temperature control, pre-registered 8 groups of PID parameters are assigned to every set temperature ranges (max. 8 zones) and perform operation by automatically changing the parameter depending on the measuring value (or setting value).

Various combinations of input and output



*Various parameter settings are available from PC by using dedicated loader software. However, it requires dedicated loader cable (sold separately).

Loader software (sold separately)

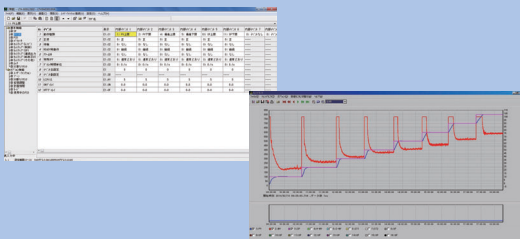

Various parameter settings and data acquisition are available by connecting this controller to the PC which the loader software is installed.

Internal event can be output as external digital (contact) output by logical operation.

On LT45A/47A...

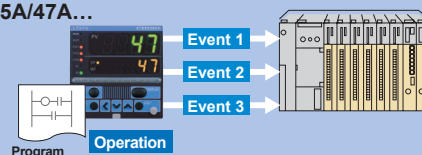

3 points of event can be output

Result of the logical operation which performed on selected five points of various internal events is able to be assigned to the three points of external digital outputs. It can simplify process of event outputs which logical operation was conventionally performed on receiver side.

SPECIFICATIONS

Input specifications

Input signal: Universal input (Thermocouple, Resistance Thermometer, DC voltage/current)
 Range type: Refer to a measuring range table
 Input sampling cycle: 100ms
 Accuracy rating: $\pm 0.1\%FS \pm 1$ digit
 Reference junction compensation accuracy: $\pm 0.5^\circ C$ (at ambient temperature $23^\circ C \pm 2^\circ C$)

Control specifications

Output type: ON-OFF pulse output type 1c 250V AC/ 30V DC 3A (resistance load)
 ON-OFF servo output type 1a 250V AC 8A(resistance load), FB resistance: 100 to 2500 Ω
 Current output type 0 to 20mA DC, 4 to 20 mA DC (It can be changed by the setting)
 Voltage output type 1 to 5V, 0 to 5V, 0 to 10V (It can be changed by the setting)
 SSR drive pulse output type 19V DC $\pm 15\%$, Internal resistance 82 Ω , Allowable current Max. 24mA DC

Event output

Output point: Max. 3 points
 Contact capacity: 250V AC/ 30V DC 2A (resistance load)
 Output type: Relay output 1a
 Type: Absolute value, deviation, loop diagnosis, timer, heater disconnection and etc. Total 33 types
 *Event output is a standard feature.

General specifications

Ambient temperature range: 0 to 50 $^\circ C$
 Power supply voltage range: AC power supply: 100 to 240 V AC, 50/60HzDC
 power supply: 24 V AC, 50/60Hz/24V DC

Power consumption: AC power supply: 12 VA and/or lower
 DC power supply: 12 VA and/or lower (24V AC) 8W and/or lower (24V DC)
 Safety standards: CE marking compliant product
 Weight: LT45A 250g, LT47A 300g

OPTION

External signal input: Input point: 4 points
 Function: AUTO/MANUAL, RUN/READY, SV, Timer Stop/Start and etc. Total 20 functions
 Transmission signal output: Current output type: 0 to 20mA DC or 4 to 20mA DC current output
 Allowable load resistance: 600 Ω and/or lower
 Output accuracy: $\pm 0.1\% FS$ (at ambient temperature $23^\circ C \pm 2^\circ C$), however, 0 to 1mA is at $\pm 1\% FS$
 Voltage output type: 0 to 5V DC/ 1 to 5V DC or 0 to 10V DC voltage output
 Allowable load resistance: 1000 Ω and/or higher
 Output accuracy: $\pm 0.1\% FS$ (at ambient temperature $23^\circ C \pm 2^\circ C$), however, 0 to 0.05V is at $\pm 1\% FS$
 Current transformer input (CT) Input point: 2 points
 CT sold separately: $\varnothing 5.8$ (LTA-P207), $\varnothing 12$ (LTA-P208)
 Measuring current: 0.4 to 50.0A
 Display accuracy: $\pm 5\% FS$
 Communication type: RS485
 Connection unit: Max. 31 units
 Communication speed: Max. 38,400bps
 Communication protocol: MODBUS
 Terminating resistor: Connection prohibited

MEASURING RANGE

Input type	C01 Set value	Measuring range	Accuracy
Thermocouple	1	-200 to 1200 $^\circ C$	$\pm 0.1\%FS \pm 1$ digit Minus area is $\pm 0.2\%FS \pm 1$ digit
	2	0 to 1200 $^\circ C$	
	3	0.0 to 800.0 $^\circ C$	
	4	0.0 to 600.0 $^\circ C$	
	5	0.0 to 400.0 $^\circ C$	
	6	-200.0 to 400.0 $^\circ C$	
	7	-200.0 to 200.0 $^\circ C$	
	8	0 to 1200 $^\circ C$	
	9	0.0 to 800.0 $^\circ C$	
	10	0.0 to 600.0 $^\circ C$	
	11	-200.0 to 400.0 $^\circ C$	
	12	0.0 to 800.0 $^\circ C$	
	13	0.0 to 600.0 $^\circ C$	
	14	-200.0 to 400.0 $^\circ C$	
	15	0 to 1600 $^\circ C$	
	16	0 to 1600 $^\circ C$	
	17	0 to 1800 $^\circ C$	
	18	0 to 1300 $^\circ C$	
	19	0 to 1300 $^\circ C$	
	20	0 to 1400 $^\circ C$	
	21	0 to 2300 $^\circ C$	
22	0 to 1300 $^\circ C$		
23	0 to 1900 $^\circ C$		
24	-200.0 to 400.0 $^\circ C$	0~300 $^\circ C$: $\pm 2.5\%FS$, 300 to 800 $^\circ C$: $\pm 1.5\%FS$, 800 to 1900 $^\circ C$: $\pm 0.5\%FS$	
25	-100.0 to 800.0 $^\circ C$	$\pm 0.1\%FS \pm 1$ digit, Minus area is $\pm 0.2\%FS \pm 1$ digit	
26	0.0 to 360.0K	$\pm 1.5K$	
41	-200.0 to 500.0 $^\circ C$	$\pm 0.1\%FS \pm 1$ digit	
42	-200.0 to 500.0 $^\circ C$		
43	-200.0 to 200.0 $^\circ C$		
44	-200.0 to 200.0 $^\circ C$		
45	-100.0 to 300.0 $^\circ C$		
46	-100.0 to 300.0 $^\circ C$		
47	-100.0 to 200.0 $^\circ C$		
48	-100.0 to 200.0 $^\circ C$		
49	-100.0 to 150.0 $^\circ C$		
50	-100.0 to 150.0 $^\circ C$		
51	-50.0 to 200.0 $^\circ C$		
52	-50.0 to 200.0 $^\circ C$		
53	-50.0 to 100.0 $^\circ C$		
54	-50.0 to 100.0 $^\circ C$		
55	-60.0 to 40.0 $^\circ C$		
56	-60.0 to 40.0 $^\circ C$		
57	-40.0 to 60.0 $^\circ C$		
58	-40.0 to 60.0 $^\circ C$		
59	-10.00 to 60.00 $^\circ C$		
60	-10.00 to 60.00 $^\circ C$		
61	0.0 to 100.0 $^\circ C$		
62	0.0 to 100.0 $^\circ C$		
63	0.0 to 200.0 $^\circ C$		
64	0.0 to 200.0 $^\circ C$		
65	0.0 to 300.0 $^\circ C$		
66	0.0 to 300.0 $^\circ C$		
67	0.0 to 500.0 $^\circ C$		
68	0.0 to 500.0 $^\circ C$		
DC voltage/current	81	0 to 10mV	$\pm 0.15\%FS \pm 1$ digit
	82	-10 to 10mV	The scaling and decimal point position can be changed variably in a range of -1999 to +9999
	83	0 to 100mV	
	84	0 to 1V	
	86	1 to 5V	
	87	0 to 5V	
	88	0 to 10V	
	89	0 to 20mA	
	90	4 to 20mA	
		$\pm 0.1\%FS \pm 1$ digit	

*Lower limit of indication value of B thermocouple is 20 $^\circ C$

●Applicable standards

• Thermocouple

K, J, E, T, R, S, B, N : JIS C 1602-1995
 Platinel II : Engelhard Industries(ITS90)
 WRe5-26 : ASTM E988-96(Reapproved 2002)
 DIN U, DIN L : DIN43710-1985
 NiMo : ASTM E1751-00

PR40-20 : Johnson Matthey
 CR-AuFe : Hayashi Denko

• Resistance thermometer

Pt100 : JIS C 1604-1997
 JPt100 : JIS C 1604-1989

ACCESSORY

Item	Model
Attachment (for terminal block type)	LTA-P307
Manual	L4A-11-□

OPTIONAL SOFTWARE

Item	Model
Loader software (cable included)	LTA-S001
Loader software	LTA-S002
Loader cable	LTA-S003

ACCESSORY (Sold separately)

Item	Model
Hard cover	LT45A LTA-P301
	LT47A LTA-P302
Soft cover	LT45A LTA-P303
	LT47A LTA-P304
Terminal cover	LT45A LTA-P305
	LT47A LTA-P306
Current transformer	LTA-P207 (5.8 mm hole dia.)
	LTA-P208 (12 mm hole dia.)
Attachment	LTA-P307
Shunt resistor 250Ω	EZ-RX250

TERMINAL BOARD

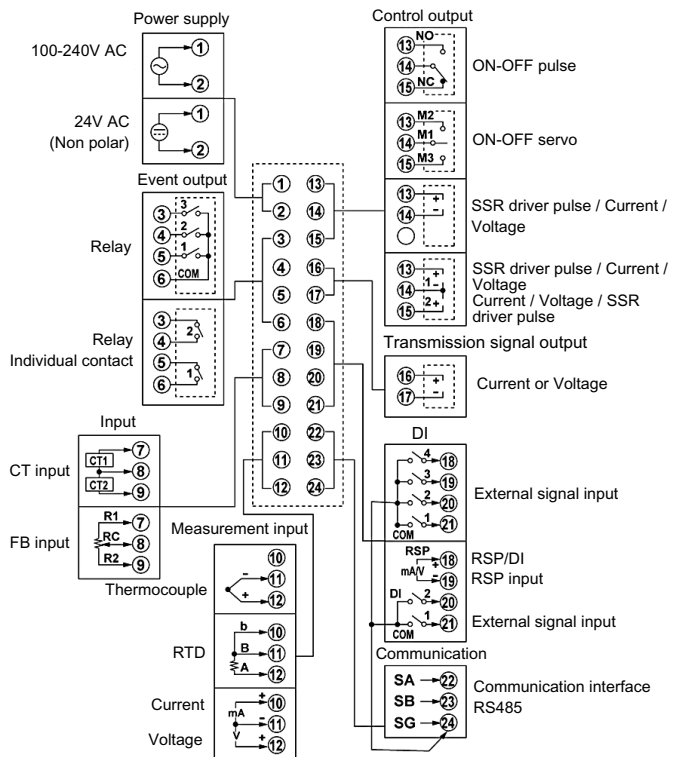

DIMENSIONS

LT47A

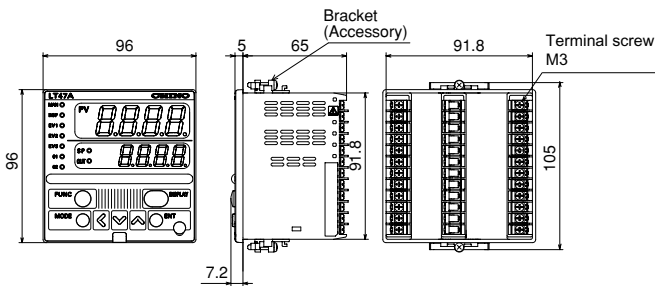

LT45A

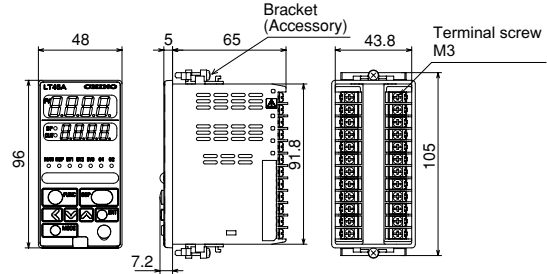

Panel cutout

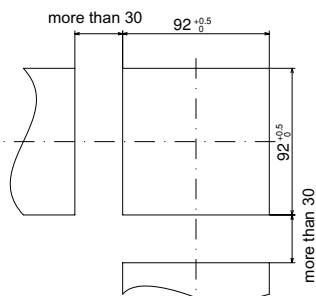

Minimum clearance for plural installation

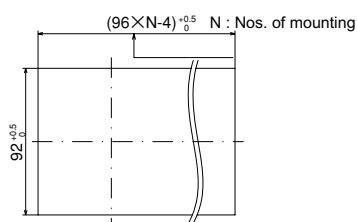

Panel cutout

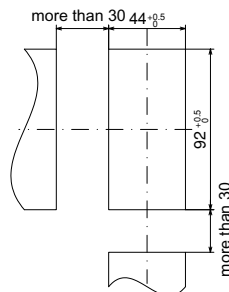

Minimum clearance for plural installation

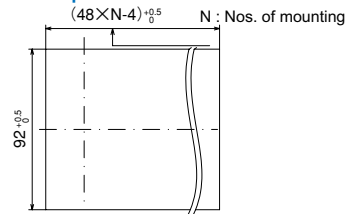

Unit : mm

Specifications subject to change without notice. Printed in Japan (I) 2014. 12

CHINO CORPORATION

32-8 KUMANO-CHO, ITABASHI-KU, TOKYO 173-8632

Telephone : +81-3-3956-2171

Facsimile : +81-3-3956-0915

E-mail : inter@chino.co.jp

Website : www.chino.co.jp/